

DETAIL PORTAIL D'ENTREE - VUE SUD

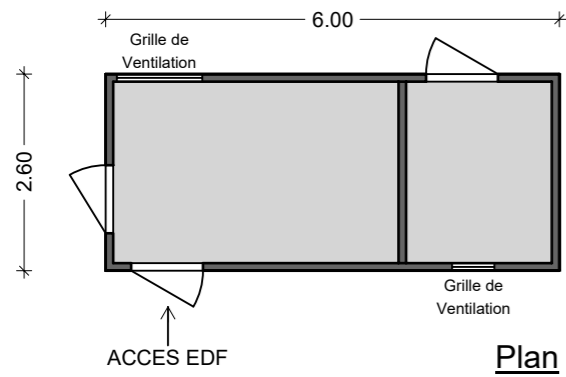

Plan

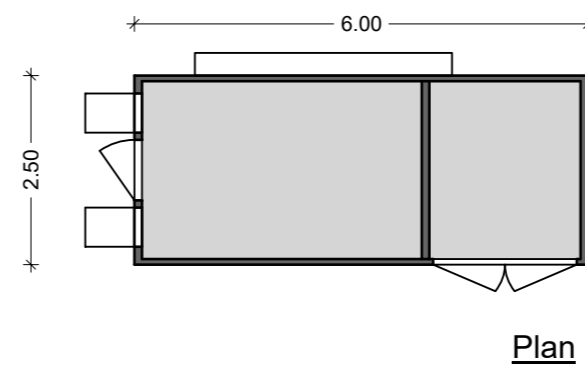

Plan

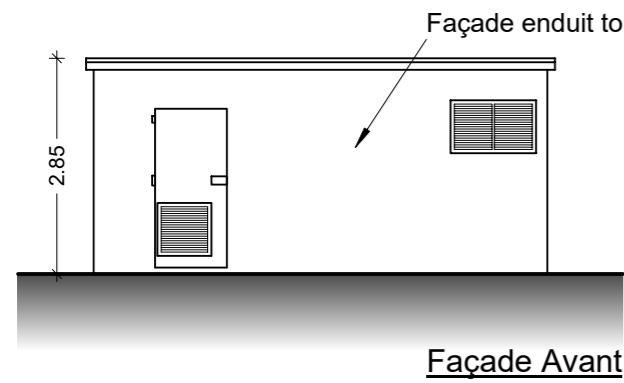

Façade Avant

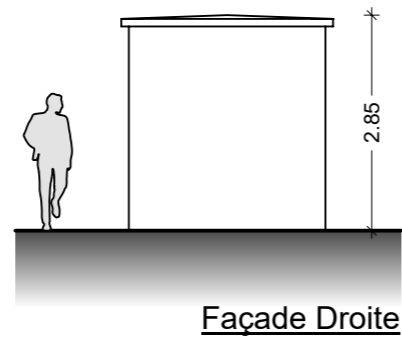

Façade Droite

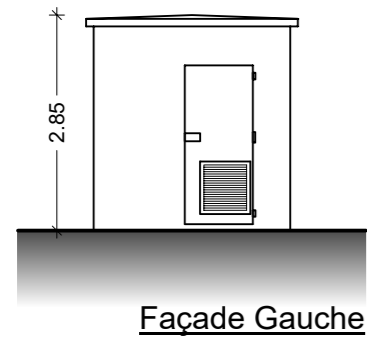

Façade Gauche

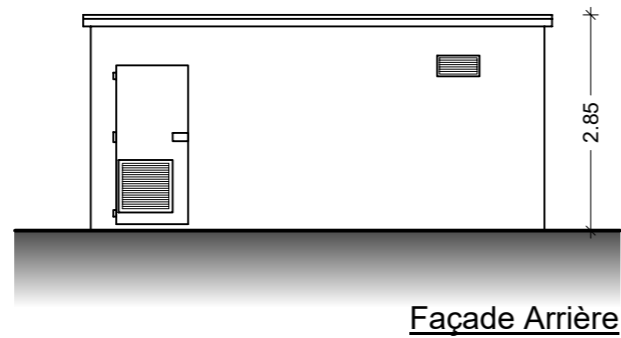

Façade Arrière

POINT DE LIVRAISON (PDL)

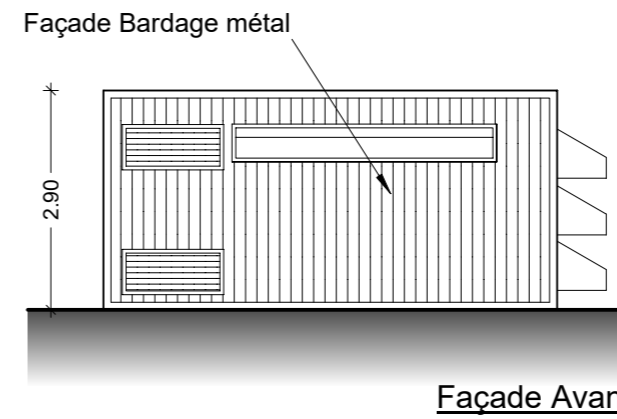

Façade Avant

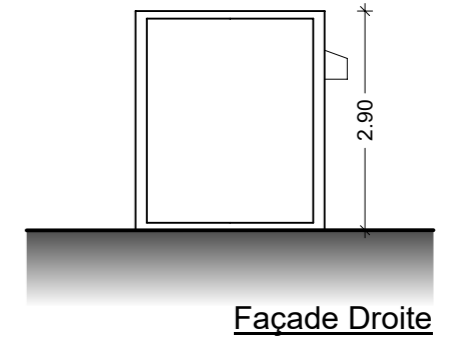

Façade Droite

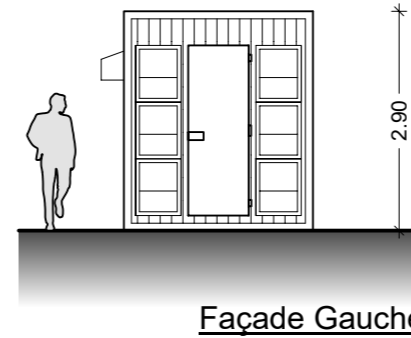

Façade Gauche

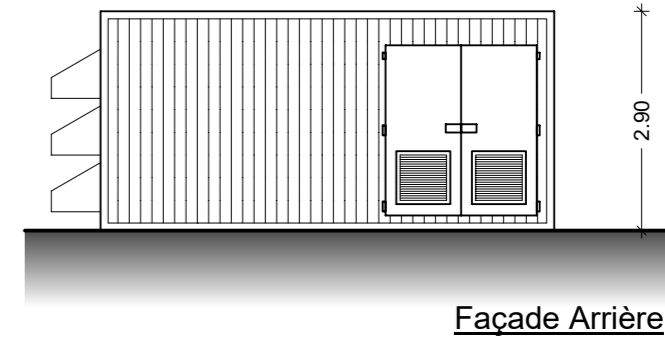

Façade Arrière

POSTE DE TRANSFORMATION (PT1, PT2 et PT3)

*Handwritten signature*